



ENGLISH

OWNER'S MANUAL

FRENCH DOOR

REFRIGERATOR

Please read this owner's manual thoroughly before operating and keep it handy for reference at all times.

GF-B620PL



MFL68680436

www.lg.com

TABLE OF CONTENTS

Safety Instructions	3–9		
Parts and Features	10	Dairy Bin	24
Refrigerator Installation	11–18	Utility Bin	24
Unpacking Your Refrigerator	11	► Freezer section	
Installation	11	Ice Bin	24
Base Cover	11	Durabase	25
How To Remove Door Handles	12	Durabase Divider	25
How To Replace Door Handles	13	Care and Cleaning	26–27
How To Remove Refrigerator Door	14	General Cleaning Tips	26
How To Remove And Install	16	Outside	26
The Pullout Drawer		Inside Walls	26
Leveling And Door Alignment	18	Door Liner and Gaskets	26
Using Your Refrigerator	19–25	Plastic Parts	26
Ensuring Proper Air Circulation	19	Condenser Coils	26
Multi-Flow	19	Power Interruptions	27
Setting the Controls	19	When you go on vacation	27
Adjusting Control Settings	20	When you move	27
Food Storage Guide	20	Smart Diagnosis	28
Storing Frozen Food	21	Troubleshooting Guide	29-32
► Refrigerator section			
Refrigerator Shelves	22		
Crisper Humidity Control	23		
Removing Crisper	23		
Glide ‘N’ Serve	23		
Modular Door Bin	24		

SAFETY MESSAGES

BASIC SAFETY PRECAUTIONS

This guide contains many important safety messages. Always **read and obey** all safety messages.



This is the safety alert symbol. It alerts you to safety messages that inform you of hazards that can cause death or serious personal injury or cause damage to the product. All safety messages will be preceded by the safety alert symbol and the hazard signal word DANGER, WARNING, CAUTION. These words mean:

! DANGER

Death, or serious injury can occur if you don't follow instructions.

! WARNING

Death, or serious injury can occur if you don't follow instructions.

! CAUTION

Indicates an imminently hazardous situation which, if not avoided, may result in minor or moderate injury, or product damage only.

All safety messages will identify the hazard, tell you how to reduce the chance of injury, and tell you what can happen if the instructions are not followed.

This appliance is intended to be used in household and similar applications such as staff kitchen areas in shops, offices and other working environments; farm houses and by clients in hotels, motels and other residential type environments; bed and breakfast type environments; catering and similar non retail applications.

! DANGER: RISK OF CHILD ENTRAPMENT

Child entrapment and suffocation are not problems of the past. Disposed or abandoned refrigerators are still dangerous...even if unattended for *just a few days*. If you are getting rid of your old refrigerator, please follow these instructions to help prevent accidents.

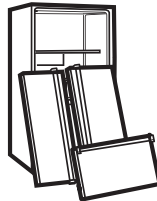

BEFORE YOU THROW AWAY YOUR OLD REFRIGERATOR OR FREEZER

- Take off the doors.
- Leave the shelves in place so that children may not easily climb inside.

CFC DISPOSAL

Your old refrigerator may have a cooling system that used CFCs (chlorofluorocarbons). CFCs are believed to harm stratospheric ozone.

If you are throwing away your old refrigerator, make sure the CFC refrigerant is removed for proper disposal by a qualified serviceman. If you intentionally release this CFC refrigerant, you can be subject to fines and imprisonment under provisions of environmental legislation.

GROUNDING REQUIREMENTS

IMPORTANT: Please read carefully.
TO CONNECT ELECTRICITY

WARNING

Electrical Shock Hazard

FOR PERSONAL SAFETY, this appliance must be properly grounded. Have the wall outlet and the circuit checked by a qualified electrician to make sure the outlet is properly grounded.

RECOMMENDED GROUNDING METHOD

The refrigerator should always be plugged into its own individual properly grounded electrical outlet rated for 240 Volts, 50 Hz, AC only, and fused at 15 amperes.

This provides the best performance and also prevents overloading house wiring circuits which could cause a fire hazard from overheated wires. It is recommended that a separate circuit serving only this appliance be provided.

Use a receptacle which cannot be turned off with a switch or pull chain. Do not use an extension cord. Where a standard two-prong wall outlet is encountered, it is your personal responsibility and obligation to have it replaced with a properly grounded three-prong wall outlet.

Do not, under any circumstances, cut or

remove the third (ground) prong from the power cord.

NOTE: Before performing any type of installation, cleaning by hand, removing dust with a vacuum cleaner, or removing a light bulb, turn the control (Thermostat, Refrigerator Control or Freezer Control, depending on the model) to OFF and then disconnect the refrigerator from the electrical source. When you are finished, reconnect the refrigerator to the electrical source and reset the control (Thermostat, Refrigerator Control or Freezer Control, depending on the model) to the desired setting.



This appliance contains a small amount of isobutane refrigerant (R600a), natural gas with high environmental compatibility, but it is also combustible. When transporting and installing the appliance, care should be taken to ensure that no parts of the refrigerating circuit are damaged. Refrigerant squirting out of the pipes could ignite or cause an eye injury. If a leak is detected, avoid any naked flames or potential sources of ignition and air the room in which the appliance is standing for several minutes.

In order to avoid the creation of a flammable gas air mixture if a leak in the refrigerating circuit occurs, the size of the room in which the appliance may be sited depends on the amount of refrigerant used. The room must be 1m³ in size for every 8g of R600a refrigerant inside the appliance. The amount of refrigerant in your particular appliance is shown on the identification plate inside the appliance. Never start up an appliance showing any signs of damage. If in doubt, consult your dealer.

WARNING

- Repair or replace immediately all electric service cords that have become frayed or otherwise damaged. Do not use a cord that shows cracks or abrasion damage along its length or at either the plug or connector end.
- When moving your refrigerator away from the wall, be careful not to roll over or damage the power cord.
- Keep fingers out of *pinch point areas*; clearances between the doors and cabinet are necessarily small. Be careful closing doors when children are in the area.
- This refrigerator must be properly installed in accordance with the **Attention Installer Instructions** that were taped to the front of the refrigerator.
- Don't touch the lamps or LED panels as they may be hot when on for a long period.
- DO NOT refreeze frozen foods which have thawed completely.
...You may safely refreeze frozen foods that have thawed if they still contain ice crystals or if they are still cold—below 4°C.
...Thawed ground meats, poultry or fish that have any off-odor or off-color should not be refrozen and should not be eaten. Thawed ice cream should be discarded. If the odor or color of any food is poor or questionable, dispose it. The food may be dangerous to eat.
Even partial thawing and refreezing reduces the eating quality of foods, particularly fruits, vegetables and prepared foods. The eating quality of red meats is affected less than that of many other foods. Use refrozen foods as soon as possible to save as much of their quality as you can.

SAVE THESE INSTRUCTIONS

IMPORTANT SAFETY INSTRUCTIONS

WARNING

- Keep ventilation openings, in the appliance enclosure or in the built-in structure, clear of obstruction.
- Do not use mechanical devices or other means to accelerate the defrosting process, other than those recommended by the manufacturer.
- Do not damage the refrigerant circuit.
- Do not use electrical appliances inside the food storage compartments of the appliance, unless they are of the type recommended by the manufacturer.
- The refrigerant and insulation blowing gas used in the appliance require special disposal procedures. When disposal, please consult with service agent or a similarly qualified person.

Don't use an extension cord

If possible, connect the refrigerator to its own individual electrical outlet to prevent it and other appliances or household lights from causing an overload that could cause a power outage.

Accessibility of Supply Plug

The refrigerator-freezer should be positioned so that the supply plug is accessible for quick disconnection should an accident happen.

Supply Cord Replacement

If the supply cord is damaged, it must be replaced by the manufacturer or its service agent or a similarly qualified person in order to avoid an electrical hazard..

WARNING

- The refrigerant and insulation blowing gas used in the appliance require special disposal procedures. When disposal, please consult with service agent or a similarly qualified person.

WARNING

- Please do not use a dishwasher to clean the lower drawers; the high temperature may cause damage to the baskets which make them unusable.

WARNING

To reduce the risk of fire, electric shock, or injury to persons when using your product, basic safety precautions should be followed, including the following. Read all instructions before using this appliance.

1. When connecting the power

A dedicated outlet should be used.

- Using several devices at one outlet may cause fire.
- If unit is connected to an earth leakage breaker it may trip resulting in spoiled food. This could occur due to power supply circumstances, and may not necessarily mean a refrigerator malfunction.

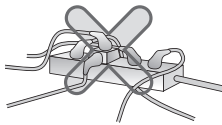

When moving your appliance away from the wall, be careful not to roll over the power cord or to damage it in any way.

It can become the cause of fire or electric shock.

Do not allow the power plug to face upward or to be crushed at the back of the refrigerator.

If the cord is crushed behind the refrigerator it may damage the cable resulting in fire. An upward facing plug may pull loose under the weight of the cord resulting in electrical failure causing fire or the fridge turning off and spoiling food.

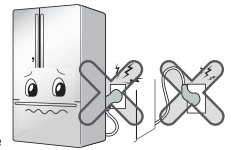

Do not allow the power cord to be bent or crushed by heavy objects.

It may damage the power cord or cause fire or electric shock

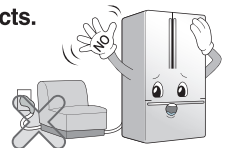

! WARNING

Do not extend or modify the length of the power plug.

It can cause electric shock or fire from incorrect installation or unsafe connection.

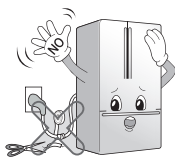

Unplug the power cord from the power outlet for cleaning or other requirements.

• Not doing so may cause electric shock or injury.

• When replacing the interior lamp of the refrigerator, make sure that the insulating rubber ring within the socket is not taken off. If the interior uses LED lighting, it can only be changed by an authorised Service provider.

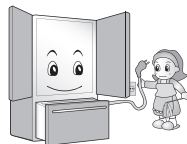

Do not pull out the cord or touch the power plug with wet hands.

It may cause electric shock or injury.

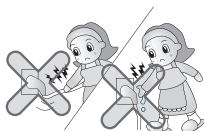

Remove water or dust from the power plug and insert it with the ends of the pins securely connected.

Dust, water or unstable connection may fire or electric shock.

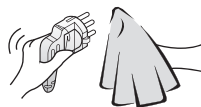

Unplug the power cord from the power outlet for cleaning or other requirements.

It may cause electric shock or injury.

Pull out the power plug by grasping the plug, not the cord.

Not doing so can cause electric shock, short circuit or fire.



Make sure of grounding.

Consult a qualified electrician or service person if the grounding instructions are not completely understood, or if you have doubts on whether the appliance is properly grounded.

The incorrect grounding may cause breakdown and electric shock.

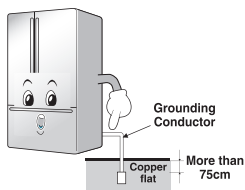

If the mains plug is removed from the wall outlet for any reason, wait for 5 minutes or longer before reconnecting the plug.

Not doing so may cause the operation of the refrigerator to fail.

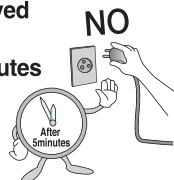

When the power cord or the power plug is damaged or the power outlet is loose or damaged, do not plug the power cord into the outlet.

Doing so may cause electric shock or be the cause of fire.

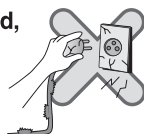

IMPORTANT SAFETY INSTRUCTIONS

2. When using the refrigerator

Do not place dangerous items, or heavy objects (including containers with liquid) on the refrigerator.

The may fall or spill and cause injury, fire or electric shock when opening or closing the door.



Do not lean on or hang from the doors or shelves of the refrigerator.

This will damage the doors and shelves of the refrigerator or cause it to topple over resulting in serious injury and damage.

Always supervise children when they are near the refrigerator.



Opening and closing the door of the refrigerator vigorously may cause the stored food in the refrigerator basket to fall out when the door is opened. Always open and close the doors with care.

Do not use any heating or drying appliances inside the refrigerator, or use lit candles to remove odours.

It may cause explosion or fire.

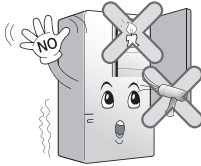

Do not use the combustible spray near the refrigerator.

It may cause explosion or fire.

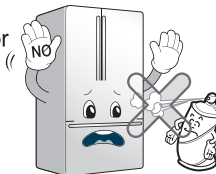

Do not store explosive substances such as aerosol cans with a flammable propellant in this appliance.

Do not install the refrigerator in a wet place or outdoors in any sheltered area where the unit can be exposed to any weathering conditions.

Weathering conditions, water or moisture will cause corrosion, rust and electrical hazards.



Never Allow children to enter or play inside the compartments of the product.

It may endanger the life of a child if the child enters the refrigerator.

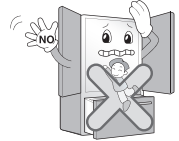

Do not use or store inflammable materials such as chemicals, solvents, benzene, alcohol, medicine, LP gas, spray or cosmetics near or in the refrigerator.

It may cause explosion or fire.

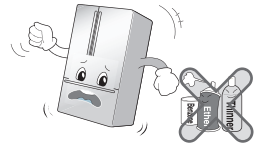

Do not store medical supplies, temperature critical medicines, or scientific materials in the refrigerator.

If materials with strict temperature restrictions are stored they may deteriorate or react undesirably resulting in possible harm or risk.

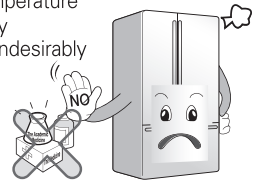

Install in places away from the heat sources such as fireplaces, heaters and ovens. Pay particular attention to avoid locating near gas related products.

Not doing so may become the cause of an explosion or fire.

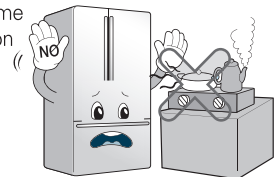

IMPORTANT SAFETY INSTRUCTIONS

Do not place flower vases, cups, cosmetics, medicine or any container with water on the refrigerator.

They may fall, leak or spill resulting in possible electric shock or fire.

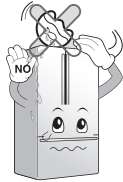

If the refrigerator has been exposed to any water submersion, it must not be used until it has been checked and certified by a licenced Electrician.

It may cause electric shock or fire.

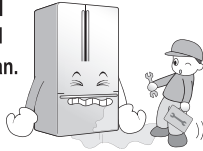

If any strange smell or smoke is detected from the refrigerator, disconnect the power plug immediately and contact to the manufacturer or an authorised service provider.

Although some smells and odors can be normal, no risks should be taken.

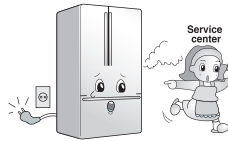

This refrigerator must not be used for any Commercial retail purpose or mobile applications. It has been designed for normal Domestic, indoor use only.

Applications outside of its intended purpose may cause malfunctions, breakages, electrical shock, fire, and loss of its stored contents.

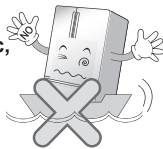

This appliance is not intended for use by persons (including children) with reduced physical, sensory or mental capabilities, or lack of experience and knowledge, unless they have been given supervision or instruction concerning use of the appliance by a person responsible for their safety.

Children should be supervised to ensure that they do not play with the appliance.

Power surges from electrical storms can seriously damage the refrigerators electrical components. If the refrigerator is not used for long periods, storage measures should be taken to avoid odours and vermin contamination.

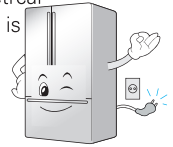

Do not spray water on the outside or the inside of the refrigerator, and do not clean it with harsh chemicals or solvents such as thinners or benzine.

Doing so can cause a fire, electric shock, malfunction. It can also damage the refrigerators finish.



Do not allow any person except a qualified engineer to disassemble, repair or alter the refrigerator.

It may cause injury, electric shock or fire.

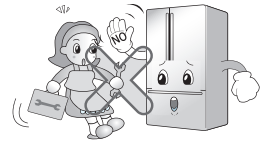

When disposing the refrigerator, remove the doors but leave the shelves in place so that children may not easily climb inside.

This can prevent prevent injury or death.

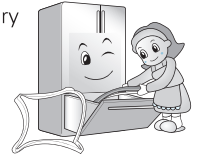

Install the refrigerator on the solid and level floor.

Installing it on the unstable place may cause death by falling down the refrigerator when opening or closing the door.

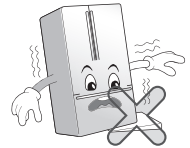

Do not insert hands or any objects or instruments into the bottom of the refrigerator, or the heatproof grill (exhaust vents) at the rear side of the cabinet.

It may cause electric shock or injury.

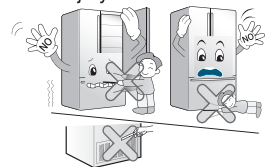

CAUTION

Violating these instructions may cause injury or damage to your home or its contents. Always be careful, please.

Do not insert hands into the ice bucket or the ice dispenser.

Operating the ice maker may cause injury.



Do not touch food or containers at the freezer with wet hands.

It may cause frostbite.

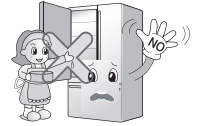

Do not dispense ice into thin crystal or ceramic ware.

It could break the glass, cup or ceramic ware and cause injury.

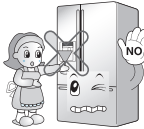

Supply the automatic ice maker with drinkable water only (only for the model with the dispenser).

Otherwise, it may cause a health risk.

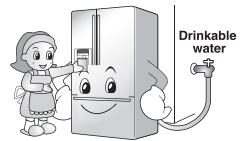

Do not place the food in disorder inside the refrigerator.

The food may fall during opening and closing the door of the refrigerator and cause injury and damage.

Do not put filled bottles in the freezer.

This will freeze the contents and break the bottle to possibly resulting in injury.



Do not insert hands into the bottom of the refrigerator.

The iron plate of the bottom may cause injury.

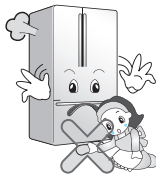

Carry the refrigerator with the handles at the bottom of the front and the top of the rear.

Otherwise, your hands may slip possibly resulting in injury or product damage.

Because the product is heavy, carrying it will require more than one person in order to avoid any possible injury.

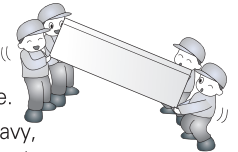

Care should be taken when opening or closing the doors to prevent injury to anyone who may be too close to the doors.

Children may be hurt by the handle or lower corners of the door when it is opened if they are too close.

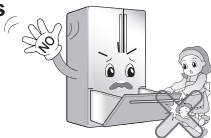

Do not put any living animal or non edible plants in the refrigerator.

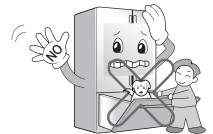

PARTS AND FEATURES

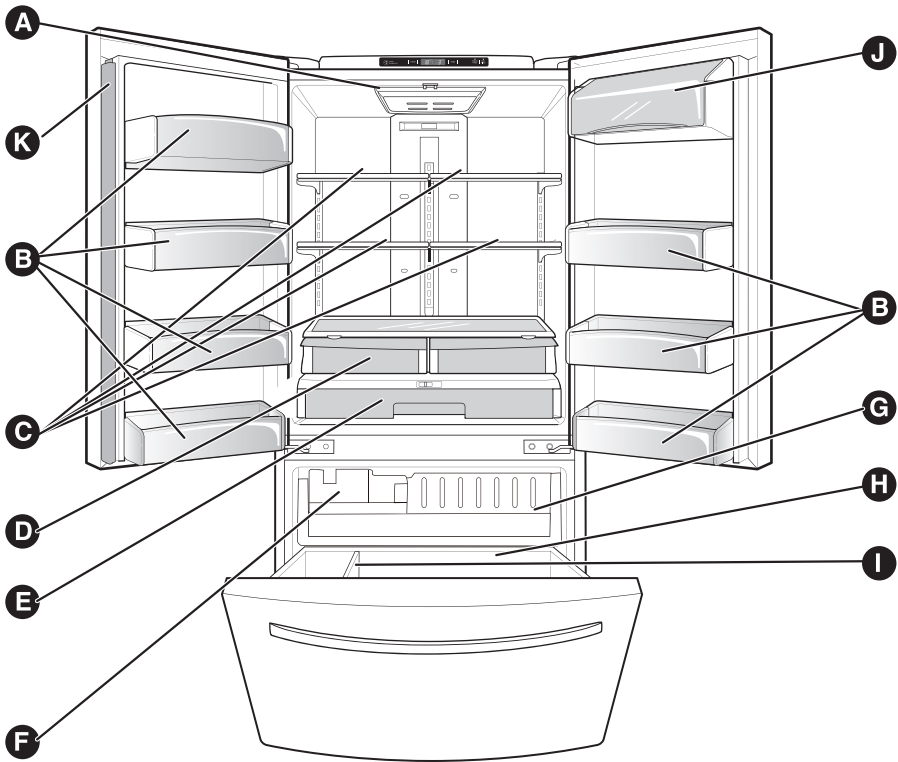

Use this page to become more familiar with the parts and features. Page references are included for your convenience.

NOTE: This guide covers several different models. The refrigerator you have purchased may have some or all of the items listed below. The locations of the features shown below may not match your model.

- | | |
|--|--------------------------|
| A Digital Sensor Control | F Ice Bin |
| B Modular Door Bins | G Pull out Drawer |
| C Shelves | H Durabase |
| D Crisper
(Keeps fruits and vegetable fresh and crisper) | I Divider |
| E Glide 'N' Serve | J Dairy Bin |
| | K M Mullion |

REFRIGERATOR INSTALLATION

⚠ WARNING

Excessive Weight Hazard

Use two or more people to move and install refrigerator.

Failure to do so can result in back or other injury.

UNPACKING YOUR REFRIGERATOR

Remove tape and any temporary labels from your refrigerator before using. Do not remove any warning-type labels, the model and serial number label, or the TechSheet that is attached to back wall of the refrigerator.

To remove any remaining tape or glue, rub the area briskly with your thumb. Tape or glue residue can also be easily removed by rubbing a small amount of liquid dish soap over the adhesive with your fingers. Wipe with warm water and dry.

Do not use sharp instruments, rubbing alcohol, flammable fluids or abrasive cleaners to remove tape or glue. These products can damage the surface of your refrigerator. For more information, see the **Important Safety Instructions** section.

Refrigerator shelves are installed in the shipping position.

Please reinstall shelves according to your individual storage needs.

⚠ WARNING

When Moving Your Refrigerator:

Your refrigerator is heavy. When moving the refrigerator for cleaning or service, be sure to protect the floor. Always pull the refrigerator straight out when moving it. Do not wiggle or walk the refrigerator when trying to move it, as floor damage could occur.

⚠ WARNING

Explosion Hazard

Keep flammable materials and vapors, such as gasoline, away from refrigerator.

Failure to do so can result in death, explosion or fire.

- To reduce the risk of electric shock, do not install the refrigerator in a wet or damp area.
- Select a place where a water supply can be easily connected for the automatic icemaker.

⚠ CAUTION: Avoid placing the unit near heat sources, direct sunlight or moisture.

INSTALLATION

- To minimize noise and vibration, the refrigerator **MUST** be installed on a solidly constructed floor.
 - Carpeting and soft tile surfaces are not recommended.
 - Never install the refrigerator on a platform or weakly supported structure.
1. To avoid vibration, the unit must be level. If required, adjust the leveling screws to compensate for unevenness of the floor. The front should be slightly higher than the rear to aid in door closing. Leveling screws can be turned easily by tipping the cabinet slightly. Turn the leveling screws clockwise (➡) to raise the unit, counterclockwise (↩) to lower it.
 2. Install this appliance in an area where the temperature is between 13°C and 43°C. If the temperature around the appliance is too low or high, cooling ability may be adversely affected.
 3. Too small a distance from adjacent items may result in lowered freezing capability and increased electricity consumption charges. Allow at least 24 in. (61 cm) in front of the refrigerator to open the doors.

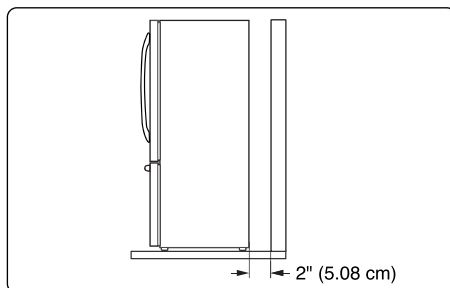

NEXT

1. Clean your refrigerator thoroughly and wipe off all dust accumulated during shipping.
2. Install accessories such as ice cube bin, drawers, shelves, etc., in their proper places. They are packed together to prevent possible damage during shipment.
3. Let your refrigerator run for at least 2 or 3 hours before putting food in it. Check the flow of cold air in the freezer compartment to ensure proper cooling. Your refrigerator is now ready for use.

BASE COVER

To remove the base cover

1. Open the Freezer Drawer. (Drawer not shown for clarity.)
2. Once drawer is open there is sufficient clearance to remove screws on top of cover.

To replace base cover:

- Place cover into position and insert and tighten screws.

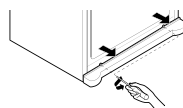

REFRIGERATOR INSTALLATION

HOW TO REMOVE DOOR HANDLES

To move refrigerator through a house door, it may be necessary to remove refrigerator and freezer door handles.

NOTE: Handle appearance may vary from illustrations on this page.

1. Removing Refrigerator Handle

- Loosen the set screws with a 3/32" Allen key and remove the handle.

NOTE: If the handle mounting fasteners need to be tightened or removed, use a 1/4" Allen key.

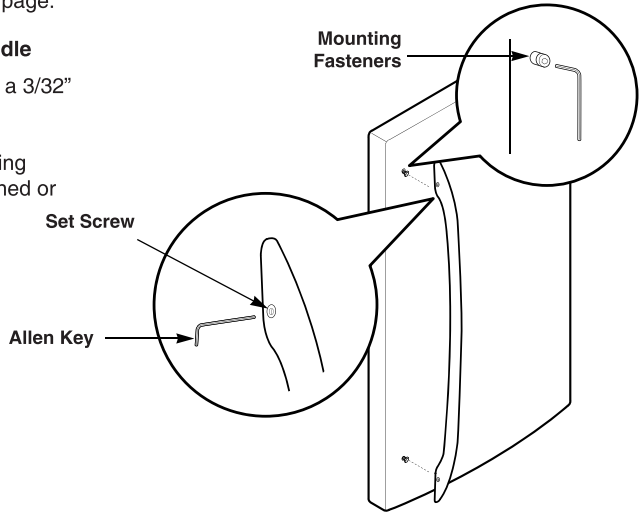

2. Removing Freezer Drawer Handle

- Loosen the set screws located on the lower side of the handle with a 1/8" Allen Key and remove the handle.

NOTE: If the handle mounting fasteners need to be tightened or removed, use a 1/4" Allen Key.

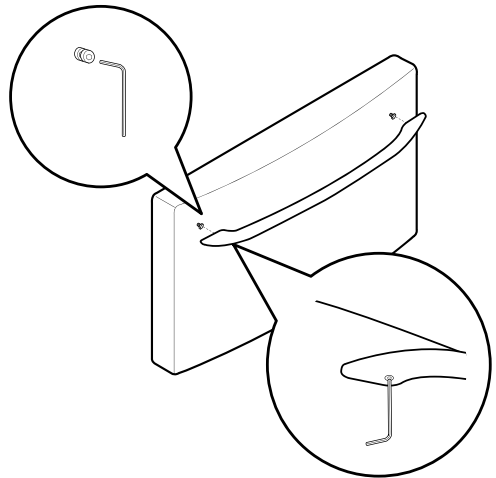

REFRIGERATOR INSTALLATION

HOW TO REPLACE DOOR HANDLES

NOTE: Handle appearance may vary from illustrations on this page.

1. Replacing Refrigerator Door Handle

- Place the handle on the door by adjusting handle footprints to fit mounting fasteners and tighten the set screws with the 3/32" Allen Key.

NOTE: If the handle mounting fasteners need to be tightened or removed use a 1/4" Allen Key.

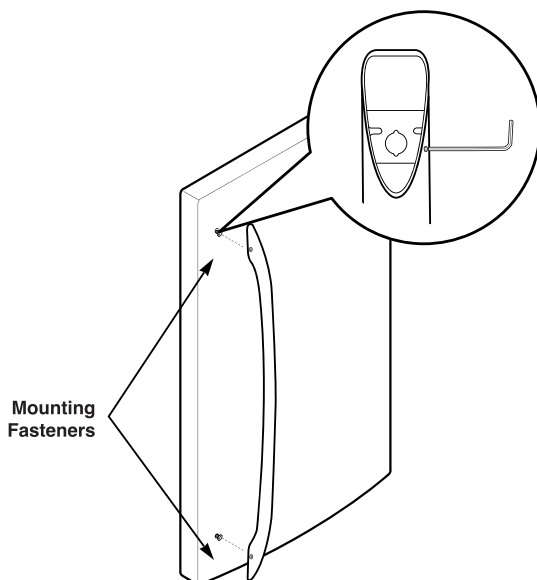

2. Replacing Freezer Drawer Handle

- Place the handle on the door by adjusting handle footprints to fit mounting fasteners and tighten the set screws on the bottom of the handle with a 1/8" Allen Key.

NOTE: If the handle mounting fasteners need to be tightened or removed use a 1/4" Allen Key.

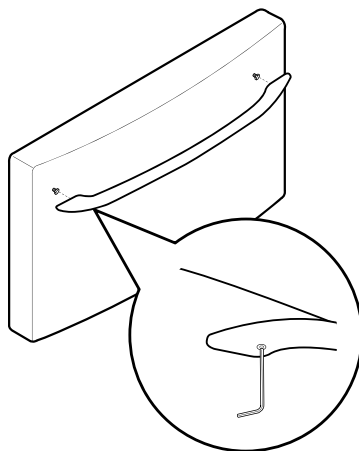

⚠ WARNING

When the customer takes apart the handle or refits it to the refrigerator, please be cautious of following things.

- Hold the handle with your own hand to make sure not to drop the handle to the floor or instep while taking apart the handle from the refrigerator.
- Do not swing the handle towards people or animals after taking apart the handle.
- Insert the bracket hole of the handle into the stopper bolt of the door exactly, and then tighten the set screws to secure the handle.
- Check if there's any gap between the door and handle after securing the handle.

REFRIGERATOR INSTALLATION

HOW TO REMOVE REFRIGERATOR DOOR

1. Removing Refrigerator Door

NOTE: Handle appearance may vary.

IMPORTANT: Before you begin, turn the refrigerator OFF and unplug it. Remove food and any bins from doors.

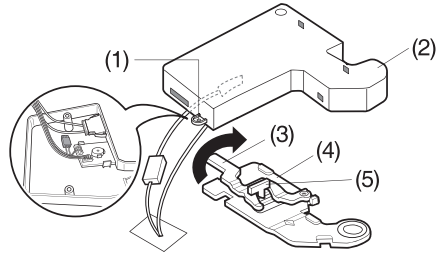
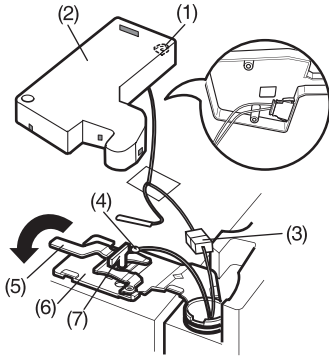

1. To remove the left refrigerator door:

- Open the door. Remove the top hinge cover screw (1).
- Use a flat blade screwdriver to lift the tabs on the front underside of the cover(2). Lift up the cover.
- Disconnect all the wire harnesses (3).
- Remove the grounding screw(4).
- Rotate hinge lever (5) counterclockwise. Lift the top hinge (6) free of the hinge lever latch (7).

IMPORTANT: When lifting the hinge free of the latch, be careful that the door does not fall forward.

- Lift the door from the middle hinge pin and remove the door.
- Place the door, inside facing up, on a non-scratching surface.

2. To remove the right refrigerator door:

- Open the door. Remove the top hinge cover screw (1).
- Use a flat blade screwdriver to lift the tabs on the front underside of the cover(2). Lift up the cover.
- Rotate hinge lever (3) clockwise. Lift the top hinge (4) free of the hinge lever latch (5).

IMPORTANT: When lifting the hinge free of the latch, be careful that the door is heavy and may fall forward.

- Lift the door from the middle hinge pin and remove the door.
- Place the door, inside facing up, on a non-scratching surface.

REFRIGERATOR INSTALLATION

2. Replacing Refrigerator Door

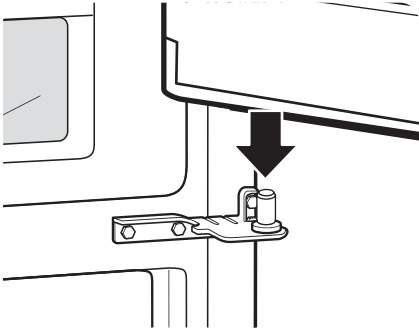

Install the right-side door first.

- Lower the door onto the middle hinge pin as shown.
- Make sure the plastic sleeve is inserted in the bottom of the door.

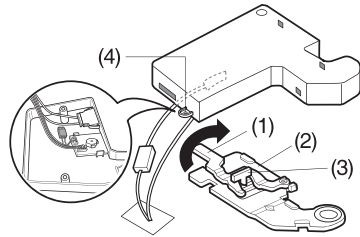

- Fit the top hinge (1) over the hinge lever latch (2) and into place. Rotate the lever (3) counterclockwise to secure the hinge.
- Insert and tighten the cover screw (4).

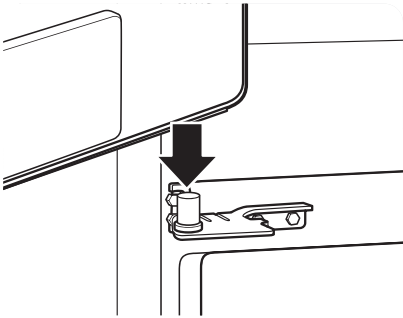

Install the left-side door.

- Lower the door onto middle hinge pin.

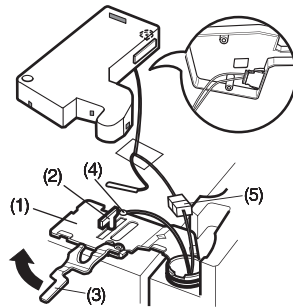

- Fit the top hinge (1) over the hinge lever latch (2) and into place. Rotate the lever (3) clockwise to secure the hinge.
- Install the grounding screw (4) and connect all the wire harnesses (5).

REFRIGERATOR INSTALLATION

HOW TO REMOVE AND INSTALL THE PULLOUT DRAWER

IMPORTANT: To avoid possible injury or product or property damage, you will need two people to perform the following instructions.

1. Removing Pullout Drawer

- Pull the drawer open to full extension. Remove the lower basket (1) by lifting basket from rail system. (If you tilt the door, it will be easier.)

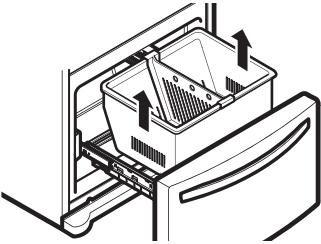

- Press both hangers with your thumbs to lift it up.
- Separate the left and right rail cover.

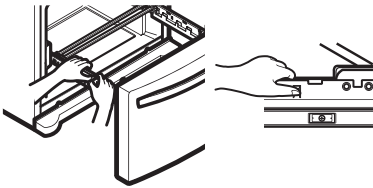

- Remove the screws (2) of the rail on both sides.

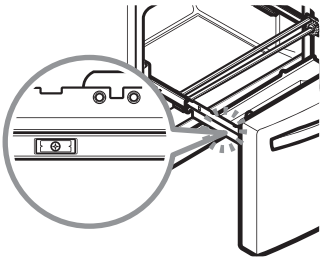

- With both hands, hold both sides of the door and pull it up to separate it from the rails.

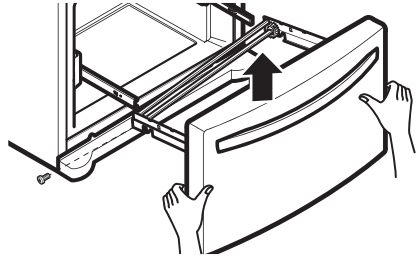

- With both hands, hold the center bar and push it in to let both rails fitted simultaneously.

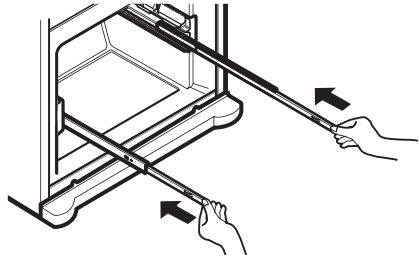

▲ CAUTION: When you remove the drawer, do not hold the handle. If it may come off and it could cause personal injury.

▲ CAUTION: When laying the drawer down, be careful not to damage the floor or hurt your feet by the sharp edges on hinge side.

REFRIGERATOR INSTALLATION

HOW TO REMOVE AND INSTALL THE PULLOUT DRAWER

IMPORTANT: To avoid possible injury or product or property damage, you will need two people to perform the following instructions.

2. Installing Pullout Drawer

- With both hands, hold the center bar and push it out to let both rails out to full extension simultaneously.

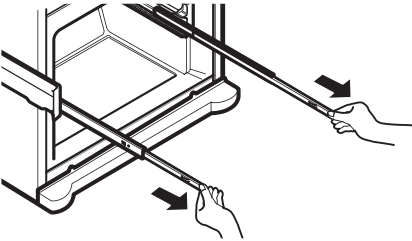

- Align the top holes of the rail cover with the top holes of the door supports to assemble the rail covers.

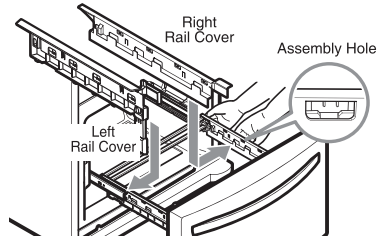

- Hook door supports (1) into rail tabs (2).

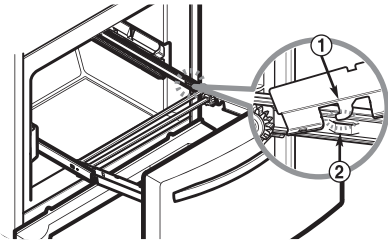

- With the drawer pulled out to full extension, insert the lower basket (4) in the rail assembly.

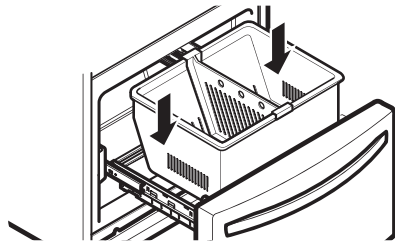

- Lower door into final position and tighten the screws (3).

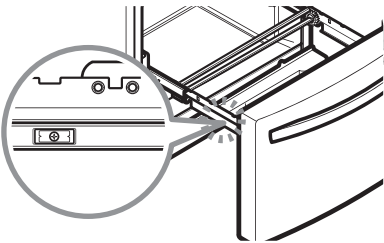

▲ **WARNING:** To prevent accidental child and pet entrapment or suffocation risk. **DO NOT** allow them to play inside of drawer.

▲ **WARNING:** **DO NOT** step or sit down on freezer door.

REFRIGERATOR INSTALLATION

LEVELING AND DOOR ALIGNMENT

Leveling

After installing, secure the product with the LEG not to move left or right.

Your refrigerator has two front leveling screws—one on the right and one on the left. If your refrigerator seems unsteady or you want the doors to close easier, adjust the refrigerator's tilt using the instructions below:

1. Plug the refrigerator's power cord into a 3-prong grounded outlet. Move the refrigerator into its final position.
2. Turn the leveling leg clockwise to raise that side of the refrigerator or counterclockwise to lower it. It may take several turns of the leveling leg to adjust the tilt of the refrigerator.
NOTE: Having someone push against the top of the refrigerator takes some weight off the leveling legs. This makes it easier to adjust the legs.

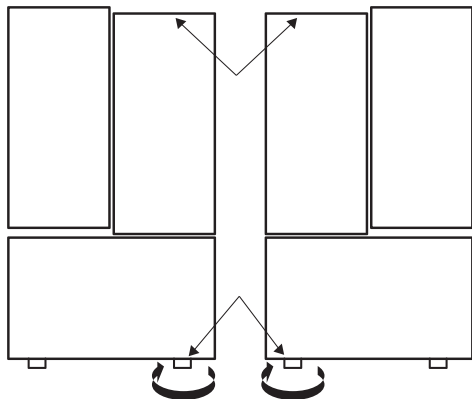

3. Open both doors again and check to make sure that they close easily. If not, tilt the refrigerator slightly more to the rear by turning both leveling screws clockwise. It may take several more turns, and you should turn both leveling screws the same amount.
4. Re-adjust if necessary.
5. Replace the base cover.

NOTE: Your new refrigerator is uniquely designed with two fresh food doors. Either door can be opened or closed independently of one another. You may have to exert slight pressure on doors to get them to close completely.

Door Alignment

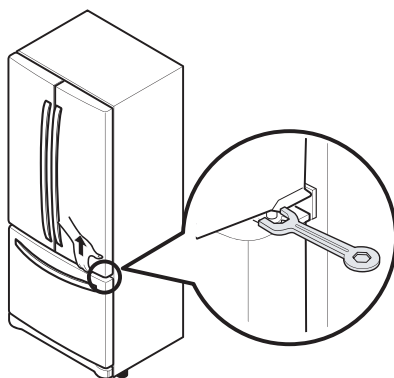

Both the left and right refrigerator doors have an adjustable nut, located on the bottom hinge, to raise and lower them to align properly. If the space between your doors is uneven, follow the instructions below to align the doors evenly:

Use the spanner (included with the Owner's Manual) to turn the nut in the door hinge to adjust the height. To the right to raise or to the left to lower the height.

USING YOUR REFRIGERATOR

ENSURING PROPER AIR CIRCULATION

In order to ensure proper temperatures, air must flow between the refrigerator and freezer sections. As shown in the illustration below, air enters at top of freezer and circulates down. From bottom of freezer, air is forced up to top of refrigerator. Air enters refrigerator through top vent, then circulates and exists at bottom, where it returns to freezer.

MULTI-FLOW

- Multi-Flow means powerful and effective cooling operation. This is especially noticeable when new food is placed in the refrigerator compartment.
- If water or foreign substances enter the cool air vent while cleaning, efficiency will be lowered. In addition, if gasket is damaged, efficiency may be lowered because of escaping cool air.

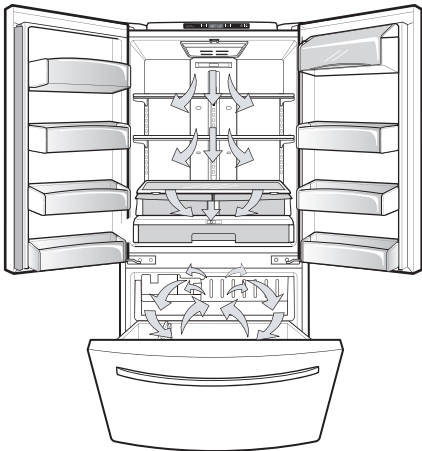

Do not block any of cool air vents with food packages. If the vents are blocked, airflow will be interrupted and temperature and moisture problems may occur.

IMPORTANT: Because air circulates between both sections, any odors formed in one section will transfer to the other. You must thoroughly clean both sections to eliminate odors. To prevent odor transfer and drying out of food, wrap or cover foods tightly. (See the Food Storage Guide section for details.)

SETTING THE CONTROLS

- Your refrigerator has two controls that let you regulate the temperature in the freezer and refrigerator compartments.
- Initially set the FRIDGE CONTROL at 3°C and the FREEZER CONTROL at -18°C. Leave it at this setting for 24 hours (one day) to stabilize. Then adjust the compartment temperature as desired.
- **Freezer control: -21°C to -13°C**
When the setting is at a higher number, the freezer compartment becomes colder. But the refrigerator compartment may become warmer because less cold air flows into the refrigerator.



- **Fridge control: 1°C to 8°C**
The lower the number setting, the colder the refrigerator compartment will become.
- **Express Freeze:**
Press the Express Freeze key and the LED will turn on. This function will remain activated for 24 hours and intensify the cooling speed of freezer.
This function will use more electricity.



▲ CAUTION

Display Mode. (OFF will be shown in the display) (For Store Use Only)

The Display Mode disables all cooling in the refrigerator and freezer sections to conserve energy while on display in a retail store. When activated, OFF will display on the control panel.

To deactivate:

Open the Right hand Refrigerator door, then while holding down the Fridge button repeatedly press the Express Freeze button 3 times.

The control panel will be on and the temperature settings will change to confirm that the Display Mode is deactivated. Use the same procedure to activate the Display Mode.

USING YOUR REFRIGERATOR

ADJUSTING CONTROL SETTINGS

Give the refrigerator time to cool down completely before making final adjustments. It is best to wait 24 hours before doing this. The mid-settings indicated in the previous section should be correct for normal household refrigerator usage. The controls are set correctly when milk or juice is as cold as you like and when ice cream is firm.

The refrigerator control functions as the thermostat for the entire appliance (refrigerator and freezer sections). The higher the number setting, the longer the compressor will run to keep the temperature colder. The freezer control adjusts the cold air flow from the freezer to the refrigerator. Setting the freezer control to a lower temperature keeps more cold air in the Freezer compartment to make it colder.

If you need to adjust temperatures in the refrigerator or freezer, start by adjusting the refrigerator. Then wait 24 hours before checking the freezer temperature. If it is too warm or too cold, then adjust the freezer control.

Use the settings listed in the chart below as a guide. **Always remember to wait at least 24 hours between adjustments.**

CONDITION/ REASON:	RECOMMENDED ADJUSTMENT:
■ REFRIGERATOR section too warm – Door opened often – Large amount of food added – Room temperature very warm	Set REFRIGERATOR control to next lower number, wait 24 hours, then re-check
■ FREEZER section too warm/ice not made fast enough – Door opened often – Large amount of food added – Very cold room temperature (can't cycle often enough) – Heavy ice usage – Air vents blocked by items	Set FREEZER control to next lower number, wait 24 hours, then re-check Move items out of airstream
■ REFRIGERATOR section too cold – Controls not set correctly for your conditions	Set REFRIGERATOR control to next higher number, wait 24 hours, then re-check
■ FREEZER section too cold – Controls not set correctly for your conditions	Set FREEZER control to next higher number, wait 24 hours, then re-check

FOOD STORAGE GUIDE

Wrap or store food in the refrigerator in airtight and moisture-proof material unless otherwise noted. This prevents food odor and taste transfer throughout the refrigerator. For dated products, check date code to ensure freshness.

Items	How to
Butter or margarine	▶ Keep opened butter in a covered dish or closed compartment. When storing an extra supply, wrap in freezer packaging and freeze.
Cheese	▶ Store in the original wrapping until you are ready to use it. Once opened, rewrap tightly in plastic wrap or aluminum foil.
Milk	▶ Wipe milk cartons. For best storage, place milk on interior shelf, not on door shelf.
Eggs	▶ Store in original carton or Utility Bin on interior shelf, not on door shelf.
Fruit	▶ Wash, let dry, and store in refrigerator in plastic bags or in the crisper. Do not wash or hull berries until you are ready to use them. Sort and keep berries in their original container in a crisper, or store in a loosely closed paper bag on a refrigerator shelf.
Leafy vegetables	▶ Remove store wrapping and trim or tear off bruised and discolored areas. Wash in cold water and drain. Place in plastic bag or plastic container and store in crisper.
Vegetables with skins (carrots, peppers)	▶ Place in plastic bags or plastic container and store in crisper.
Fish	▶ Use fresh fish and shellfish the same day purchased.
Leftovers	▶ Cover leftovers with plastic wrap or aluminum foil. Plastic containers with tight lids can also be used.

USING YOUR REFRIGERATOR

STORING FROZEN FOOD

NOTE: For further information about preparing food for freezing or food storage times, check a freezer guide or a reliable cookbook.

Packaging

Successful freezing depends on correct packaging. When you close and seal the package, it must not allow air or moisture in or out. If it does, you could have food odor and taste transfer throughout the refrigerator and also dry out frozen food.

Packaging recommendations:

- Rigid plastic containers with tight-fitting lids
- Straight-sided canning/freezing jars
- Heavy-duty aluminum foil
- Plastic-coated paper
- Non-permeable plastic wraps
- Specified freezer-grade self-sealing plastic bags

Follow package or container instructions for proper freezing methods.

Do not use

- Bread wrappers
- Non-polyethylene plastic containers
- Containers without tight lids
- Wax paper or wax-coated freezer wrap
- Thin, semi-permeable wrap

▲ CAUTION : Do not keep beverage cans or plastic food containers in the freezer compartment. They may be break if they freezer.

Freezing

Your freezer will not quick-freeze any large quantity of food. Do not put more unfrozen food into the freezer than will freeze within 24 hours (no more than 2 to 3 lbs of food per cubic foot of freezer space). Leave enough space in the freezer for air to circulate around packages. Be careful to leave enough room at the front so the door can close tightly.

Storage times will vary according to the quality and type of food, the type of packaging or wrap used (airtight and moisture-proof) and the storage temperature. Ice crystals inside a sealed package are normal. This simply means that moisture in the food and air inside the package have condensed, creating ice crystals.

NOTE: Allow hot foods to cool at room temperature for 30 minutes, then package and freeze. Cooling hot foods before freezing saves energy.

USING YOUR REFRIGERATOR

REFRIGERATOR SECTION

REFRIGERATOR SHELVES

The shelves in your refrigerator are adjustable to meet your individual storage needs. Your model may have glass or wire shelves.

Storing similar food items together in your refrigerator and adjusting the shelves to fit different heights of items will make finding the exact item you want easier; it will also reduce the amount of time the refrigerator door is open, saving energy.

IMPORTANT: Do not clean glass shelves with warm water when they are cold. Shelves may break if exposed to sudden temperature changes or impact, such as bumping. For your protection, glass shelves are made with tempered glass, which will shatter into small pebble-sized pieces.

NOTE: Glass shelves are heavy. Use special care when removing them to avoid dropping them.

Adjusting Shelves

Remove shelves from the shipping position and replace shelves in the desired position.

- **To remove a shelf**—Tilt up the front of the shelf in the direction of (1) and lift it in the direction of (2). Pull the shelf out.

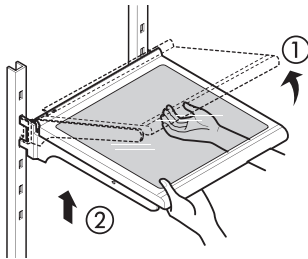

- **To reinstall a shelf**—Tilt the front of the shelf up and guide the shelf hooks into the slots at a desired height. Then lower the front of the shelf so that the hooks drop into the slots.

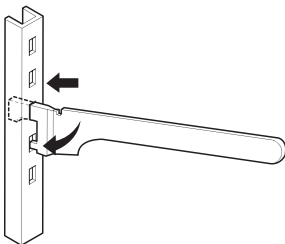

- ▲ **CAUTION :** Make sure that shelves are level from one side to the other. Failure to do so may result in the shelf falling or spilling food.

Sliding Out Shelves

You can slide glass shelves in and out of your refrigerator as follows.

- **To slide the shelf out**, carefully pull front of shelf toward you.
- **To slide shelf in**, push shelf in until it stops.

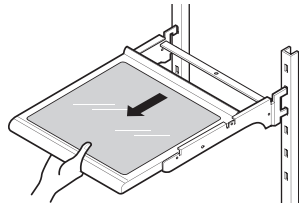

USING YOUR REFRIGERATOR

CRISPER HUMIDITY CONTROL

You can control the amount of humidity in the moisture-sealed crispers. Store vegetables or fruits requiring more or less humidity in separate crispers. Adjust the control to any setting between **HIGH** and **LOW**.

- **LOW** lets moist air out of the crisper for best storage of fruits.
- **HIGH** keeps moist air in the crisper for best storage of fresh, leafy vegetables.

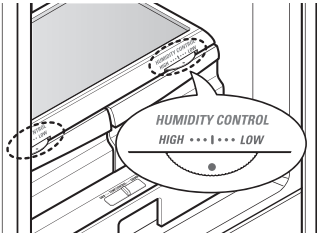

▲ CAUTION : The glass shelf over the crisper is may not be firmly secured. Be careful when tilting.

REMOVING CRISPER

1. To remove, pull the drawer out to full extension.
2. Lift the front of the crisper up, then pull it straight out.
3. To install, slightly tilt up the front and insert the drawer into the frame and push it back into place.

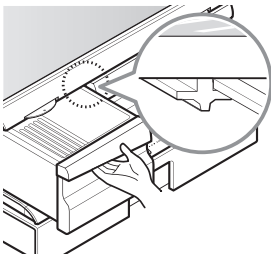

To remove glass shelf

1. Lift up the glass under the crisper cover.
2. Pull the glass up and out.

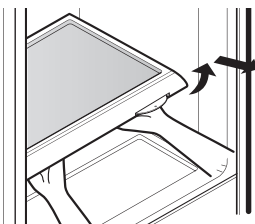

GLIDE'N'SERVE

The **Glide'N'Serve** provides storage space with a variable temperature control that has the ability to keep the compartment slightly (proportionally) colder than refrigerator.

This drawer can be used for large party trays, deli items, or beverages. (this drawer should not be used for vegetables as they will freeze.)

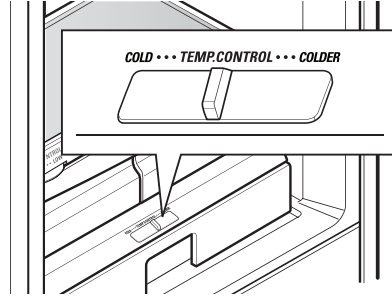

Controls

The control regulates the air temperature in the drawer. Set control level to **COLD** to provide normal refrigerator temperature. Use the **COLDER** setting for meats or other deli items.

NOTE: Selecting the **COLDER** position on the Glide'N'Serve can affect the refrigerator temperature. Refrigerator control may need to be re adjusted to a colder temperature.

To replace Glide'N'Serve

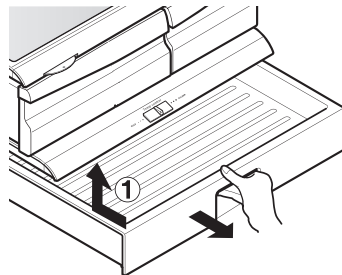

1. To remove, pull the drawer out to full extension.
2. Lift the front of the drawer up, then pull it straight out.
3. To install, slightly tilt up the front and insert the drawer into the frame and push it back into place.

USING YOUR REFRIGERATOR

MODULAR DOOR BIN

The door bins are removable for easy cleaning and adjusting.

1. To remove the bin, simply lift the bin up and pull straight out.
2. To replace the bin, slide it in above the desired support stoppers and push down until it stops.

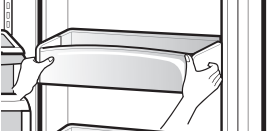

▲ **WARNING** : Injury or damage can occur if door bins are not firmly assembled.

NOTE : DO NOT adjust a bin that is loaded with food.

▲ **CAUTION** : DO NOT allow children to play with baskets. Sharp corners on baskets could cause injury.

DAIRY BIN

1. To remove the dairy bin, simply lift it and pull straight out.
2. To replace the dairy bin, slide it in above the support stoppers and push down until it stops.

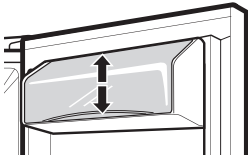

FREEZER SECTION

ICE BIN

1. To separate the ice bin, pull out the drawer as much as possible.
2. Gently lift and pull out the ice bin.
3. To install, pull out the drawer as much as possible and set the ice bin in its correct position, then push in the drawer.

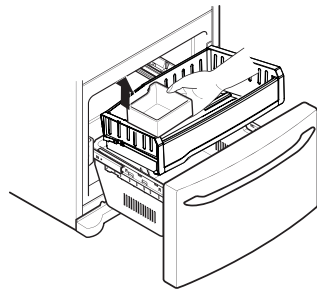
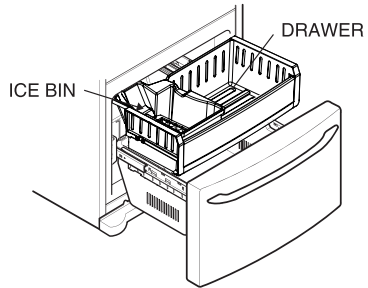

USING YOUR REFRIGERATOR

DURABASE

1. To remove the Durabase, push it back to the end as much as possible. Tilt up the front of the Durabase and pull straight out.
2. To install, insert the Durabase in rail assembly.

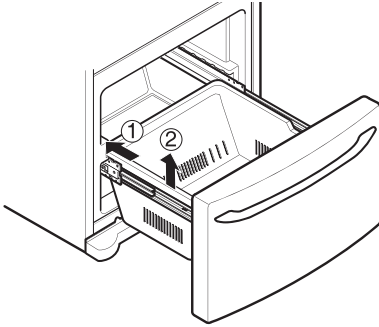

DURABASE DIVIDER

The Durabase divider allows you to organize the Durabase area into two sections.

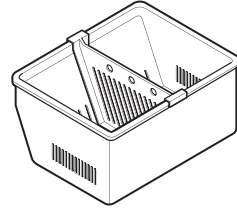

▲ WARNING : If the Durabase divider is removed, there is enough open space for children or pets to crawl inside. To prevent accidental child and pet entrapment or suffocation risk, **DO NOT** allow them to play inside of drawer.

CARE AND CLEANING



WARNING



Explosion Hazard

Use non-flammable cleaner.

Failure to do so can result in death, explosion, or fire.

Both the refrigerator and freezer sections defrost automatically. However, clean both sections about once a month to prevent odors. Wipe up spills immediately.

GENERAL CLEANING TIPS

- Unplug refrigerator or disconnect power.
- Remove all removable parts, such as shelves, crispers, etc. Refer to sections in Using Your Refrigerator for removal instructions.
- Use a clean sponge or soft cloth and a mild detergent in warm water. Do not use abrasive or harsh cleaners.
- Hand wash, rinse and dry all surfaces thoroughly.
- Plug in refrigerator or reconnect power.

OUTSIDE

Waxing external painted metal surfaces helps provide rust protection. Do not wax plastic parts. Wax painted metal surfaces at least twice a year using appliance wax (or auto wax or finishing polish). Apply wax with a clean, soft cloth.

For products with a stainless steel exterior, use a clean sponge or soft cloth and a mild detergent in warm water. Do not use abrasive or harsh cleaners. Dry thoroughly with a soft cloth.

INSIDE WALLS (allow freezer to warm up so cloth won't stick)

To help remove odors, you can wash the inside of the refrigerator with a mixture of baking soda and warm water. Mix 2 tablespoons baking soda to 1 liter of warm water.

Be sure the baking soda is completely dissolved so it does not scratch the surfaces of the refrigerator.

▲ CAUTION: Do not use a water sprayer when cleaning the inside.

DOOR LINERS AND GASKETS

Do not use cleaning waxes, concentrated detergents, bleaches, or cleaners containing petroleum on plastic refrigerator parts.

PLASTIC PARTS (covers and panels)

Do not use window sprays, abrasive cleansers, or flammable fluids. These can scratch or damage the material.

CONDENSER COILS

Disconnect the Mains power cord from the wall outlet before removing the lower Back cover. Use a vacuum cleaner with an extended attachment to clean condenser coils. Vacuum coils when dusty or dirty. Coils may need to be cleaned as often as every other month.

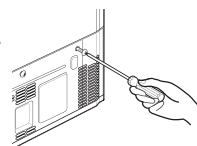

CARE AND CLEANING

POWER INTERRUPTIONS

1. If the power will be out for 24 hours or less, keep all refrigerator doors closed to help foods stay cold and frozen.
2. If the power will be out for more than 24 hours:
 - a) Remove all frozen food and store it in a frozen food locker.

WHEN YOU GO ON VACATION

If you choose to leave the refrigerator off while you are away, follow these steps to prepare your refrigerator before you leave.

1. Use up any perishables and freeze other items.
2. Empty the ice bin.

If you choose to turn the refrigerator off before you leave, follow these steps.

1. Remove all food from the refrigerator.
2. Disconnect the plug from the mains power outlet.
3. Clean refrigerator, wipe it and dry well.
4. Tape rubber or wood blocks to the tops of both doors to prop them open far enough for air to get in. This stops odor and mold from building up.

WHEN YOU MOVE

When you are moving your refrigerator to a new home, follow these steps to prepare it for the move.

1. Remove all food from the refrigerator and pack all frozen food in dry ice.
2. Unplug the refrigerator.
3. Clean, wipe and dry thoroughly.
4. Take out all removable parts, wrap them well and tape them together so they don't shift and rattle during the move. Refer to sections in Using your Refrigerator for removal instructions.
5. Depending on the model, raise the front of the refrigerator so it rolls more easily OR screw in the leveling legs all the way so they don't scrape the floor. See the **Door Closing** section.
6. Tape the doors shut and tape the power cord to the refrigerator cabinet.

When you get to your new home, put everything back and refer to the **Installing Your Refrigerator** section for preparation instructions.

WARNING

Lamp Replacement

If LED lamp is damaged, it should be replaced by the service center in stead of on your own.

SMART DIAGNOSIS



Should you experience any problems with your refrigerator, it has the capability of transmitting data via your telephone to the LG service center. This gives you the capability of speaking directly to our trained specialists. The specialist records the data transmitted from your machine and uses it to analyze the issue, providing a fast and effective diagnosis.

If you experience problems with your refrigerator, call 1300 54 2273. Only use the Smart Diagnosis feature when instructed to do so by the LG call center agent. The transmission sounds that you will hear are normal and sound similar to a fax machine.

Smart Diagnosis cannot be activated unless your refrigerator is connected to power. If your refrigerator is unable to turn on, then troubleshooting must be done without using Smart Diagnosis.

Using Smart Diagnosis

First, call 1300 54 2273. Only use the Smart Diagnosis feature when instructed to do so by the LG call center agent.

- 1 Hold the mouthpiece of your phone in front of the speaker that is located on the right hinge of the refrigerator door, when instructed to do so by the call center.

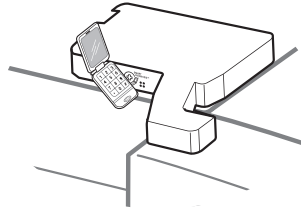

- 2 Press and hold the Freezer Temperature button for three seconds while continuing to hold your phone to the speaker.



- 3 After you hear three beeps, release the Freezer Temperature button.
- 4 Keep the phone in place until the tone transmission has finished. The display will count down the time. Once the countdown is over and the tones have stopped, resume your conversation with the specialist, who will then be able to assist you in using the information transmitted for analysis.

! NOTE

- For best results, do not move the phone while the tones are being transmitted.
- If the call center agent is not able to get an accurate recording of the data, you may be asked to try again.

! NOTE

- Call quality differences by region may affect the function.
- Use the home telephone for better communication performance, resulting in better service.
- Bad call quality may result in poor data transmission from your phone to the machine, which could cause Smart Diagnosis to not work properly.

TROUBLESHOOTING GUIDE

UNDERSTANDING SOUNDS YOU MAY HEAR

Your new refrigerator may make sounds that your old one didn't make. Because the sounds are new to you, you might be concerned about them. Most of the new sounds are normal. Hard surfaces, like the floor, walls and cabinets, can make the sounds seem louder than they actually are. The following describes the kinds of sounds and what may be making them.

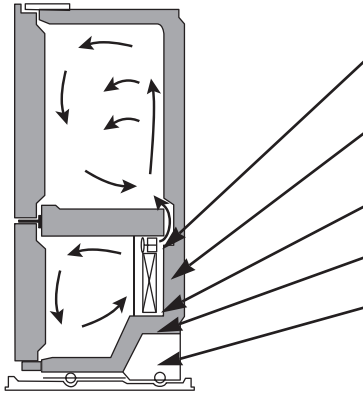

- The defrost timer will click when the automatic defrost cycle begins and ends. The thermostat control (or refrigerator control, depending on the model) will also click when cycling on and off.
- Rattling noises may come from the flow of refrigerant, the water line, or items stored on top of the refrigerator.
- Your refrigerator is designed to run more efficiently to keep your food items at the desired temperature. The high efficiency compressor may cause your new refrigerator to run longer than your old one, and you may hear a pulsating or high-pitched sound.
- You may hear the evaporator fan motor circulating the air through the refrigerator and freezer compartments.
- As each cycle ends, you may hear a gurgling sound due to the refrigerant flowing in your refrigerator.
- Contraction and expansion of the inside walls may cause a popping noise.
- Water dripping on the defrost heater during a defrost cycle may cause a sizzling sound.
- You may hear air being forced over the condenser by the condenser fan.
- You may hear water running into the drain pan during the defrost cycle.

	Check if...	Then...
REFRIGERATOR DOES NOT OPERATE	The power supply cord is unplugged. A household fuse has blown or circuit breaker tripped. The refrigerator control is set to the OFF position. Refrigerator is in the defrost cycle.	<ul style="list-style-type: none"> ▶ Firmly plug the cord into a live outlet with proper voltage. ▶ Replace the fuse or reset the circuit breaker. ▶ Refer to the Setting the Controls section on page 19. ▶ Wait about 30 minutes for defrost cycle to end.
VIBRATION OR RATTLING NOISE	The refrigerator is not resting evenly on the floor.	<ul style="list-style-type: none"> ▶ Floor is weak or uneven or leveling legs need adjusting. See Installation section on page 11.
LIGHTS DO NOT WORK	The power supply cord is unplugged. Light bulb is loose in the socket. Light bulb has burned out. If the Refrigerator is fitted with LED lighting, it must be checked or replaced by a qualified Service provider. Door is left open for seven continuous minutes.	<ul style="list-style-type: none"> ▶ Firmly plug the cord into a live outlet with proper voltage. ▶ Turn the refrigerator control to the OFF position and unplug the refrigerator. Gently remove the bulb and reinsert. Then plug in refrigerator and reset the refrigerator control. ▶ Replace with an appliance bulb of the same wattage, size and shape available at your local hardware store. (See the Changing the Light Bulb(s) section on pages 26–27.) Turn the temperature control to the OFF position and unplug the refrigerator prior to replacement. ▶ Shutting door for one second will light bulbs to come back on.

TROUBLESHOOTING GUIDE

	Check if...	Then...
<p>COMPRESSOR MOTOR SEEMS TO RUN TOO MUCH</p>	<p>The refrigerator that was replaced was an older model. The room temperature is hotter than normal.</p> <p>The door is opened often or a large amount of food has just been added.</p> <p>The refrigerator was recently plugged in and the refrigerator control was set correctly. The refrigerator control is not set correctly for the surrounding conditions. The doors are not closed completely.</p> <p>The condenser coils are dirty.</p>	<ul style="list-style-type: none"> ▶ Modern refrigerators with more storage space require more operating time. ▶ The motor will run longer under warm conditions. At normal room temperatures, expect your motor to run about 40% to 80% of the time. Under warmer conditions, expect it to run even more often. ▶ Adding food and opening the door warms the refrigerator. It is normal for the refrigerator to run longer in order to cool the refrigerator back down. Adding a large amount of food warms the refrigerator. See the Food Storage Guide section on page 20. In order to conserve energy, try to get everything you need out of the refrigerator at once, keep food organized so it is easy to find and close the door as soon as the food is removed. ▶ The refrigerator will take up to 24 hours to cool completely. ▶ See the Adjusting Control Settings section on page 20. ▶ Push the doors firmly shut. If they will not shut all the way, see Doors will not close completely below. ▶ This prevents air transfer and makes the motor work harder. Clean the condenser coils. Refer to the Care and Cleaning section on pages 26–27.
<p>DOORS WILL NOT CLOSE COMPLETELY</p>	<p>The refrigerator is not level.</p> <p>Food packages are blocking the door open. The ice bin, crisper cover, pans, shelves, door bins or baskets are out of position.</p> <p>The gaskets are sticking.</p> <p>The refrigerator wobbles or seems unstable.</p> <p>The doors were removed during product installation and not properly replaced.</p>	<ul style="list-style-type: none"> ▶ See Leveling and Door Alignment on page 18. ▶ Rearrange food containers to clear door and door shelves. ▶ Push bins all the way in and put crisper cover, pans, shelves and baskets into their correct positions. See the Using Your Refrigerator section on pages 19–25. ▶ Clean gaskets and the surface that they touch. Rub a thin coat of paraffin wax on the gaskets after cleaning. ▶ Level the refrigerator. Refer to the Leveling and Door Alignment section on page 18. ▶ Remove and replace the doors according to the Removing and Replacing Refrigerator handles and doors section on pages 12–17, or call a qualified service technician.
<p>FROST OR ICE CRYSTALS ON FROZEN FOOD</p>	<p>The door is not closing properly.</p> <p>The door is opened often.</p>	<ul style="list-style-type: none"> ▶ See Doors will not close completely above. ▶ When the door is opened, warm, humid air is allowed in the freezer, resulting in frost.

TROUBLESHOOTING GUIDE

	Check if...	Then...
ICE HAS OFF-TASTE OR ODOR	<p>The icemaker was recently installed.</p> <p>The ice has been stored for too long.</p> <p>The food has not been wrapped tightly in either compartment.</p> <p>The water supply contains minerals such as sulfur.</p> <p>The interior of refrigerator needs cleaning.</p> <p>Ice storage bin needs cleaning.</p>	<ul style="list-style-type: none"> ▶ Discard first few batches of ice to avoid discolored or off-flavored ice. ▶ Throw away old ice and make new supply. ▶ Rewrap foods since odors may migrate to the ice if food is not wrapped properly. ▶ A filter may need to be installed (or replaced) to eliminate taste and odor problems. ▶ See Care and Cleaning section on pages 26–27. ▶ Empty and wash bin. Discard old cubes.
THERE IS WATER IN THE DEFROST DRAIN PAN	<p>The refrigerator is defrosting.</p> <p>It is more humid than normal.</p>	<ul style="list-style-type: none"> ▶ The water will evaporate. It is normal for water to drip into the defrost pan. ▶ Expect that the water in the defrost pan will take longer to evaporate. This is normal when it is hot or humid.
THE REFRIGERATOR SEEMS TO MAKE TOO MUCH NOISE	<p>The sounds may be normal for your refrigerator.</p>	<ul style="list-style-type: none"> ▶ Refer to the Understanding Sounds You May Hear section on page 32.
THE DOORS ARE DIFFICULT TO OPEN	<p>The gaskets are dirty or sticky.</p> <p>The door is reopened within a short time after having been opened.</p>	<ul style="list-style-type: none"> ▶ Clean gaskets and the surfaces that they touch. Rub a thin coat of appliance polish or kitchen wax on the gaskets after cleaning. ▶ When you open the door, warmer air enters the refrigerator. As the warm air cools, it can create a vacuum. If the door is hard to open, wait 5 minutes to allow the air pressure to equalize, then see if it opens more easily.

TROUBLESHOOTING GUIDE

	Check if...	Then...
<p>TEMPERATURE IS TOO WARM OR THERE IS INTERIOR MOISTURE BUILDUP</p>	<p>The air vents are blocked. Cold air circulates from the freezer to the fresh food section and back again through air vents in the wall dividing the two sections.</p>	<ul style="list-style-type: none"> ▶ Locate air vents by using your hand to sense airflow and move all packages that block vents and restrict airflow. Refer to Multi-Flow on page 19 for the location of air vents.
	<p>The doors are opened often.</p>	<ul style="list-style-type: none"> ▶ When the door is opened, warm humid air is allowed into the refrigerator. The more the door is opened, the faster the humidity builds up, and the more warm air the refrigerator must cool. In order to keep the refrigerator cool, try to get everything you need out of the refrigerator at once, keep food organized so it is easy to find and close the door as soon as the food is removed.
	<p>The control is not set correctly for the surrounding conditions.</p>	<ul style="list-style-type: none"> ▶ Refer to the Setting the Controls section on page 19. Wait 24 hours for temperatures to stabilize or even out. If the temperature is too cold or too warm, move the dial one number at a time.
	<p>A large amount of food has just been added to the refrigerator or freezer.</p>	<ul style="list-style-type: none"> ▶ Adding food warms the refrigerator. It can take a few hours for the refrigerator to return to normal temperature.
	<p>The food is not packaged correctly.</p>	<ul style="list-style-type: none"> ▶ Wrap food tightly and wipe off damp containers prior to storing in the refrigerator to avoid moisture accumulation. If necessary, repackage food according to the guidelines in the Food Storage Guide section on page 20.
	<p>The doors are not closing completely.</p>	<ul style="list-style-type: none"> ▶ See Doors will not close completely on page 33.
	<p>The weather is humid.</p>	<ul style="list-style-type: none"> ▶ In humid weather, air carries moisture into refrigerator when doors are opened.
	<p>A self-defrost cycle was completed.</p>	<ul style="list-style-type: none"> ▶ It is normal for droplets to form on the back wall after the refrigerator self-defrosts.

